

# VESNA STARTER BATTERIES

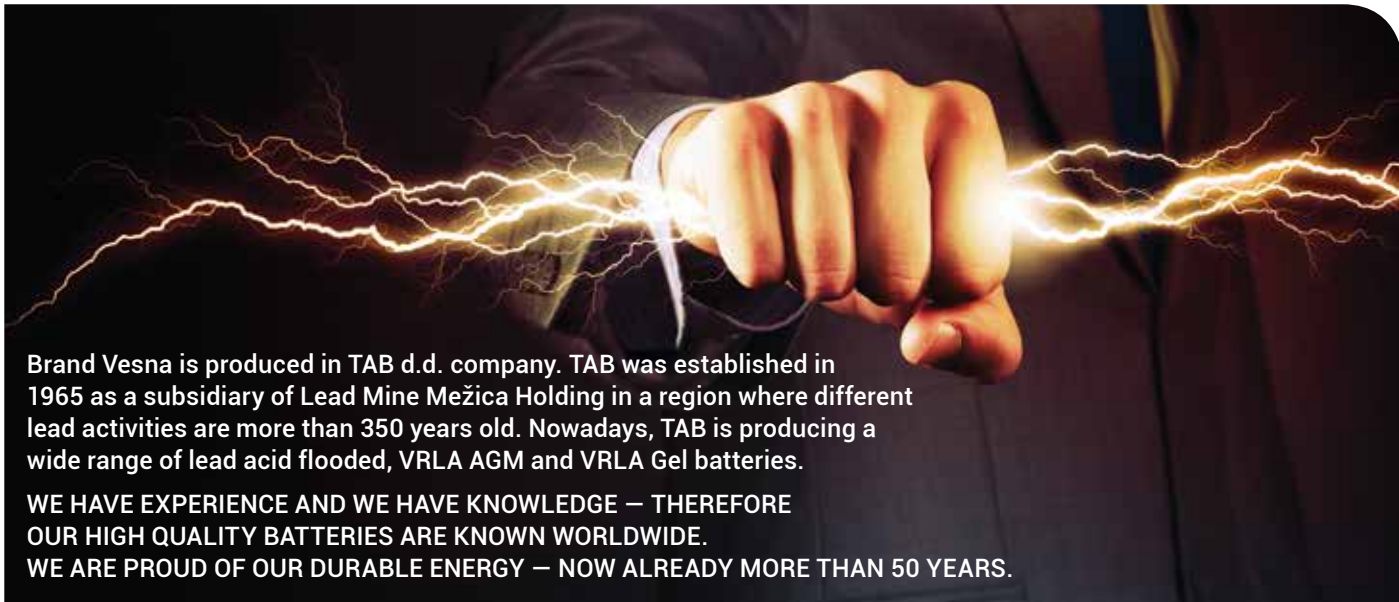

VESNA POWER  
VESNA POWER TRUCK  
VESNA PREMIUM TRUCK  
VESNA PREMIUM  
VESNA EFB Stop & Go  
VESNA AGM Stop & Go



Brand Vesna is produced in TAB d.d. company. TAB was established in 1965 as a subsidiary of Lead Mine Mežica Holding in a region where different lead activities are more than 350 years old. Nowadays, TAB is producing a wide range of lead acid flooded, VRLA AGM and VRLA Gel batteries.

WE HAVE EXPERIENCE AND WE HAVE KNOWLEDGE – THEREFORE OUR HIGH QUALITY BATTERIES ARE KNOWN WORLDWIDE.  
WE ARE PROUD OF OUR DURABLE ENERGY – NOW ALREADY MORE THAN 50 YEARS.

TAB Tovarna Akumulatorskih Baterij d. d., Polena 6, SI-2392 Mežica, Slovenia | info@tab.si | +386 (0)2 8702 300 | www.tab.si

# ENERGY IN MOTION

## EMS TRUCK BATTERIES

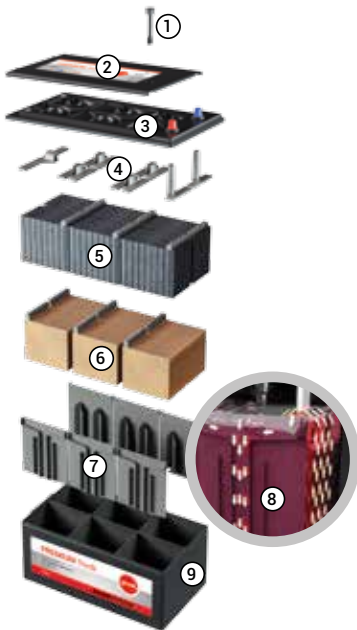

- 1 Electrolyte level indicator – Magic Eye
- 2 Top SMF lid with central degassing and flame arrestors (Battery manufactured by using Sb/Ca technology is fitted with a Flat lid with M27 plugs, for easy access)
- 3 Main SMF lid with labyrinth for additional safety and very low water loss
- 4 Robust plate connectors with large surface inter cell welds, increasing cranking power
- 5 Negative plate with additives for increased charging abilities. Permanent sulfation is severely restricted
- 6 Positive plates with thick casted grids. High-density active mass increases cycle life plus enhanced resistance to deep discharge
- 7 Integrated flexible ribs which generate adequate pressure to the plate stack in all states of charge
- 8 New cell design promotes acid motion in vertical direction, eliminating stratification
- 9 Impact resistant polypropylene container

## Allowable shelf life (SELFDISCHARGE)

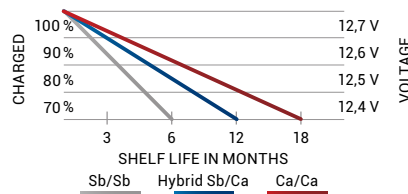

## Water consumption (g/Ah)

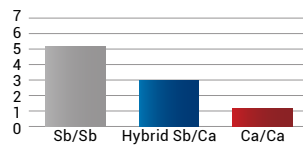

## Layout

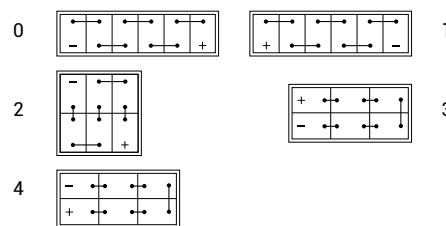

## Glossary of remarks

- K** Kamina
- H** Handle
- KH** Kamina Handle
- ME** Magic Eye
- HD** Heavy Duty
- JIS** Japanese Poles
- SMF** Maintenance Free = Sealed
- DP** Dual Poles
- A** Pole Adapter
- AGM** Absorbed Glass Mat
- EMS** Electrolyte Mixing System

## Base hold down

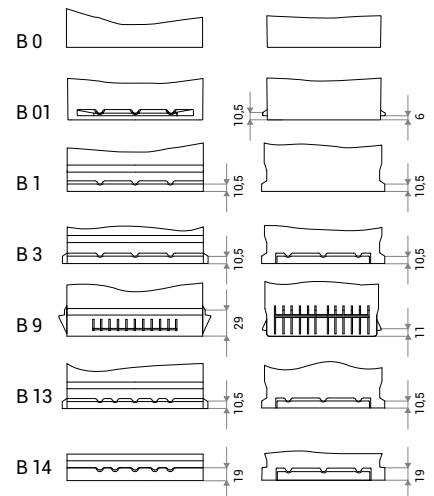

## Terminals

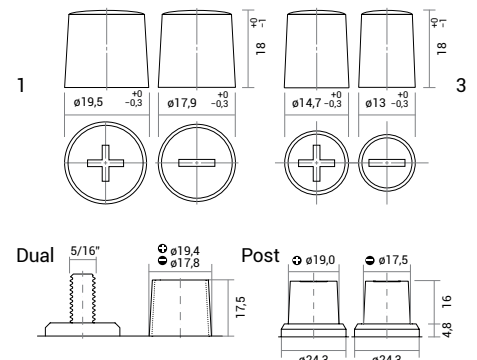

**VESNA POWER** is battery produced using Ca/Ca expanded metal technology designed for vehicles with entry level of electric equipment with demand of superior starting, performance and reliability. Vesna Power is real all rounder offering excellent power, capacity, cold start performance and reliability. SMF lid/cover provides complete roll over spill protection and is entirely maintenance free throughout the batteries life. This is high quality product for vehicles of every class.

- + High starting capabilities
- + Sealed cover construction
- + Explosion protection prevents flame brake-in into the battery
- + Reliable starting at extreme climatic conditions



## VESNA POWER

Flooded starter batteries, Ca/Ca technology | CAR batteries

ID	DIN marking	JIS marking (old/new)	Short code	C20 (Ah)	RC (min)	Box type	EN (A)	LxWxH (mm)	BHD	Layout	Weight (kg)	PCS/Pallet (EUR/CNT)	Remarks
415035	53520 SMF	NS40ZL SMF, 36B20L SMF	P035J	35	53	53520	300	196x128x202/223	B0	0	9,4	96/128	SMF, H, JIS
415135	53522 SMF	NS40Z SMF, 36B20R SMF	P035JX	35	53	53522	300	196x128x202/223	B0	1	9,4	96/128	SMF, H, JIS
415235	53521 SMF	NS40ZL SMF, 36B20L SMF	P035JP	35	53	53520	300	196x134x202/223	B01	0	9,4	96/128	SMF, H, JIS
235845	54506		B45	45	71	L0	400	175x175x190	B13	0	10,5	72/120	K
415036	53649 SMF		B36	36	55	L1B	330	207x175x175	B13	0	10,2	80/120	SMF, H
415244	54002 SMF		P040	40	62	L1B	360	207x175x175	B13	0	10,6	72/120	SMF, H
415344	54003 SMF		P040X	40	62	L1B	360	207x175x175	B13	1	10,6	72/120	SMF, H
415046	54502 SMF		P045	45	71	L1B	420	207x175x175	B13	0	11,3	72/120	SMF, H
415445	54559 SMF		B45H	45	71	L1	400	207x175x190	B13	0	11,7	72/100	SMF, H
415250	55010 SMF		P050H	50	81	L1	450	207x175x190	B13	0	12,2	72/100	SMF, H
415045	54520 SMF	NS60LS BHD	P045J	45	71	53520	400	196x134x202/223	B1	0	10,6	72/96	SMF, H, JIS
415145	54522 SMF	NS60S BHD	P045JX	45	71	53522	400	196x134x202/223	B1	1	10,6	72/96	SMF, H, JIS
415645	54523/84 SMF	NS60LS SMF, 46B24LS SMF	P045JA	45	71	54523/84	400	236x128x202/223	B0	0	11,9	72/96	SMF, H, JIS, A
415745	54524/51 SMF	NS60S SMF, 46B24RS SMF	P045JAX	45	71	54524/51	400	236x128x202/223	B0	1	11,9	72/96	SMF, H, JIS, A
415855	55523/84 SMF		P055JA	55	90	54523/84	540	236x128x202/223	B0	0	13,5	72/96	SMF, H, JIS, A
415755	55524/51 SMF		P055JAX	55	90	54524/51	540	236x128x202/223	B0	1	13,5	72/96	SMF, H, JIS, A
415245	55001 SMF		B54	54	88	L2B	450	242x175x175	B13	0	12,8	63/108	SMF, H
415255	55509 SMF		P055	55	90	L2B	500	242x175x175	B13	0	13,3	63/108	SMF, H
415260	56009 SMF		P060	60	100	L2B	550	242x175x175	B13	0	13,9	63/108	SMF, H
415360	56265 SMF		P060X	60	100	L2B	550	242x175x175	B13	1	13,9	63/108	SMF, H
415655	55559 SMF		B55H	55	90	L2	500	242x175x190	B13	0	14,0	63/90	SMF, H
415262	56008 SMF		P060H	60	100	L2	600	242x175x190	B13	0	14,4	63/90	SMF, H
415063	56068 SMF	N50ZL SMF, 55D23L SMF	P060J	60	100	56068	600	230x173x200/220	B01	0	14,8	60/90	SMF, ME, H
415160	56069 SMF	N50Z SMF, 55D23R SMF	P060JX	60	100	56069	600	230x173x200/220	B01	1	14,8	60/90	SMF, ME, H
415866	56568 SMF		P065J	65	110	56068	650	230x173x200/220	B01	0	15,3	60/90	SMF, ME, H
415965	56569 SMF		P065JX	65	110	56069	650	230x173x200/220	B01	1	15,3	60/90	SMF, ME, H
415263	56309 SMF		B68	68	116	L3B	600	278x175x175	B13	0	15,4	51/80	SMF, H, HD
415073	57309 SMF		P073	73	126	L3B	630	278x175x175	B13	0	15,9	51/80	SMF, H, HD
415273	56638 SMF		B73H	73	126	L3	600	278x175x190	B13	0	16,1	51/80	SMF, H, HD
415074	57412 SMF		P074H	74	128	L3	680	278x175x190	B13	0	17,1	51/80	SMF, H, HD
415374	57413 SMF		P074HX	74	128	L3	680	278x175x190	B13	1	17,1	51/80	SMF, H, HD
415270	57029 SMF	NS70L SMF, 65D26L SMF	P070J	70	120	57029	700	259x175x200/221	B1	0	17,0	48/80	SMF, ME, H
415370	57024 SMF	NS70 SMF, 65D26R SMF	P070JX	70	120	57024	700	259x175x200/221	B1	1	17,0	48/80	SMF, ME, H
415875	57529 SMF		P075J	75	130	57029	740	259x175x200/221	B1	0	17,6	48/80	SMF, ME, H
415775	57524 SMF		P075JX	75	130	57024	740	259x175x200/221	B1	1	17,6	48/80	SMF, ME, H
415292	59249 SMF		B92H	92	165	L4	800	315x175x190	B13	0	19,9	42/60	SMF, H, HD
415478	58803 SMF		B88	88	156	L5B	720	353x175x175	B13	0	19,9	36/72	SMF, H, HD
415092	59220 SMF		P092	92	165	L5B	800	353x175x175	B13	0	20,4	36/72	SMF, H, HD
415192	59221 SMF		P092X	92	165	L5B	800	353x175x175	B13	1	20,4	36/72	SMF, H, HD
415088	58827 SMF		B88H	88	156	L5	720	353x175x190	B13	0	20,7	36/60	SMF, H, HD
415000	60038 SMF		P010H	100	182	L5	850	353x175x190	B13	0	21,7	36/60	SMF, H, HD
415295	59518 SMF	NX120-7L SMF, 105D31L SMF	P095J	95	171	59518	850	306x173x200/221	B01	0	20,5	42/70	SMF, ME, H
415395	59519 SMF	NX120-7 SMF, 105D31R SMF	P095JX	95	171	59519	850	306x173x200/221	B01	1	20,5	42/70	SMF, ME, H
235110	61002		B11H	110	203	L6	1000	394x175x190	B13	0	24,5	36/60	KH, HD
415495	BCI 31 SMF		P95BCI	95	171	BCI 31	700	330x173x218/239	B1	0	24,4	42/60	SMF, ME, H, HD
415410	BCI 31S SMF		P110BCI	110	203	BCI 31	1000	330x173x218/239	B1	0	25,7	42/60	SMF, ME, H, HD
415695	BCI 31 SMF-D		P95BCID	95	171	BCI 31	700	330x173x218/237	B1	0	24,4	42/60	SMF, ME, H, HD, DP
415610	BCI 31S SMF-D		P110BCID	110	203	BCI 31	1000	330x173x218/237	B1	0	25,7	42/60	SMF, ME, H, HD, DP

## VESNA POWER TRUCK

Flooded starter batteries, Sb/Ca technology | TRUCK batteries | Flat lid with M27 plugs

ID	DIN marking	Short code	C20 (Ah)	RC (min)	Box type	EN (A)	LxWxH (mm)	BHD	Layout	Weight (kg)	PCS/Pallet (EUR/CNT)	Remarks
235805	61028	VT11	110	203	60528	800	345x172x218/238	B0	0	25,3	36/48	H
235605	61028	VT11P	110	203	60528	800	345x175x218/238	B1	0	25,3	36/48	H
632912	61044	VT11M	110	203	MAC110	720	509x175x182/208	B3	3	31,1	24/32	H, HD
240810	62047	VT12	120	225	60528	900	345x172x218/238	B0	0	26,7	36/48	H
235825	62512	VT12H	125	235	62512	800	345x172x269/289	B0	0	31,8	24/36	H
958912	63530	VT13A	135	258	A	850	513x189x194/220	B0	3	35,6	24/35	H, HD
607912	63544	VT13M	135	258	MAC110	850	509x175x182/208	B3	3	33,3	24/40	H, HD
959912	63545	VT13MR	135	258	MAC110	850	509x175x182/208	B3	4	33,3	24/40	H, HD
960912	64323	VT14M	143	258	MAC143	900	509x216x184/210	B3	3	38,7	21/35	H, HD
167913	64548	VT14B	145	280	B	900	512x222x194/221	B0	3	39,7	21/28	H, HD, EMS
611912	65048	VT15M	150	292	MAC110	1000	509x175x182/208	B3	3	36,9	24/32	H, HD
168913	67018	VT17	170	338	B	1050	512x222x194/221	B0	3	42,7	21/28	H, HD, EMS
169913	67019	VT17R	170	338	B	1050	512x222x194/221	B0	4	42,7	21/28	H, HD, EMS
171913	68032	VT18	180	361	B	1100	512x222x194/221	B0	3	43,7	21/28	H, HD, EMS
172913	69032	VT19	190	385	B	1200	512x222x194/221	B0	3	45,4	21/28	H, HD, EMS
173913	70032	VT20B	200	409	B	1200	512x222x194/221	B0	3	45,4	21/28	H, HD, EMS
963912	70027	VT20C	200	409	C	1200	518x273x214/241	B0	3	52,7	18/24	H, HD, EMS
964912	72527	VT22	225	469	C	1300	518x273x214/241	B0	3	56,1	18/24	H, HD, EMS
600712	6TN	VT11D7	110	203	D7	740	282x269x208/230	B0	2	30,8	24/36	H, HD



**VESNA TRUCK**

## VESNA PREMIUM TRUCK

Flooded starter batteries, Ca/Ca technology | TRUCK batteries

ID	DIN marking	Short code	C20 (Ah)	RC (min)	Box type	EN (A)	LxWxH (mm)	BHD	Layout	Weight (kg)	PCS/Pallet (EUR/CNT)	Remarks
188612	63544 SMF	VTP13M	135	258	MAC110	850	509x175x196/223	B3	3	33,3	24/40	SMF, ME, H, HD
232612	64030 SMF	VTP14	140	269	A	850	507x188x200/228	B0	3	35,6	24/35	SMF, ME, H, HD
189612	65048 SMF	VTP15M	150	292	MAC110	1000	509x175x196/223	B3	3	36,9	24/40	SMF, ME, H, HD
440612	65018 SMF	VTP15	150	292	B	950	513x222x194/221	B0	3	40,4	24/32	SMF, ME, H, HD, EMS
441612	68032 SMF	VTP18	180	361	B	1100	513x222x194/221	B0	3	43,5	21/28	SMF, ME, H, HD, EMS
192612	70027 SMF	VTP20	200	409	C	1200	517x275x214/241	B0	3	52,7	18/24	SMF, ME, H, HD, EMS
193612	72527 SMF	VTP22	225	469	C	1300	517x275x214/241	B0	3	56,1	18/24	SMF, ME, H, HD, EMS



**VESNA PREMIUM** utilises the latest innovations in Ca/Ca manufacturing technology, providing for the highest cold start performance and superior reliable power as demanded by the latest generation of cars with high energy drain. The SMF lid/cover provides complete roll over spill protection and is entirely maintenance free throughout the batteries life.

- + Sealed cover construction
- + Higher number of plates ensure 30% better starting capabilities
- + The expanded metal technology results in better corrosion resistance and providing a longer life time
- + The level indicator (magic eye) provides an instant status check
- + Explosion protection prevents flame brake-in into the battery
- + Ideal for cars with lots of electrical equipment
- + Battery of highest quality



## VESNA PREMIUM

Flooded starter batteries, Ca/Ca technology | CAR batteries

ID	DIN marking	Short code	C20 (Ah)	RC (min)	Box type	EN (A)	LxWxH (mm)	BHD	Layout	Weight (kg)	PCS/Pallet (EUR/CNT)	Remarks
415254	55401 SMF	PR54	54	88	L1B	510	207x175x175	B13	0	12,3	72/120	SMF, ME, H
415455	55510 SMF	PR55H	55	90	L1	560	207x175x190	B13	0	12,8	72/100	SMF, ME, H
415062	56249 SMF	PR62	62	104	L2B	600	242x175x175	B13	0	14,5	63/108	SMF, ME, H
415266	56649 SMF	PR66H	66	112	L2	640	242x175x190	B13	0	15,0	63/90	SMF, ME, H
415075	57510 SMF	PR75	75	130	L3B	720	278x175x175	B13	0	16,5	51/80	SMF, ME, H, HD
415275	57549 SMF	PR75H	78	130	L3	750	278x175x190	B13	0	17,5	51/80	SMF, ME, H, HD
415082	58514 SMF	PR85	85	150	L4B	800	315x175x175	B13	0	18,8	42/72	SMF, ME, H, HD
415095	60032 SMF	PR100	100	182	L5B	850	353x175x175	B13	0	21,1	36/72	SMF, ME, H, HD
415100	60044 SMF	PR100H	100	182	L5	900	353x175x190	B13	0	22,3	36/60	SMF, ME, H, HD

## ENERGY IN MOTION



# OUR CONTRIBUTION T

**VESNA EFB Stop & Go** batteries are so called Enhanced Flooded Batteries intended for use in vehicles with entry level Start-Stop function. EFB batteries utilize the latest innovations in Ca/Ca flooded battery manufacturing technology, providing for the superior reliable power as demanded by the latest generation of cars with entry level Start-Stop system.

- + MFW fleece on positive plates, preventing active material shedding boast twice as much cyclic capability as standard batteries and can be more discharged without any loss of functionality
- + Improved charge acceptance for recovering energy more quickly during driving phase using special expander with carbon
- + The expanded metal technology results in better corrosion resistance providing a longer life time
- + Sealed cover construction, roll over proof
- + Maintenance free
- + The level indicator (magic eye) provides an instant status check
- + Explosion protection with flame arrestor



## VESNA EFB Stop & Go

EFB starter batteries, Ca/Ca technology | CAR batteries

ID	DIN marking	JIS marking (old/new)	Short code	C20 (Ah)	RC (min)	Box type	EN (A)	LxWxH (mm)	BHD	Layout	Weight (kg)	PCS/Pallet (EUR/CNT)	Remarks
312260	56068 SMF	N50ZL SMF, 55D23L SMF	VSG60J	60	100	56068	600	230x173x200/220	B01	0	16,4	60/90	SMF, ME, H
312160	56069 SMF	N50Z SMF, 55D23R SMF	VSG60JX	60	100	56069	600	230x173x200/220	B01	1	16,4	60/90	SMF, ME, H
312060	56088 SMF		VSG60	60	100	L2	580	242x175x190	B13	0	16,4	63/90	SMF, ME, H
313065	56588 SMF		VSG65	65	110	L3B	650	278x175x175	B13	0	15,9	51/80	SMF, ME, H, HD
313070	57088 SMF		VSG70	70	120	L3	680	278x175x190	B13	0	19,0	51/80	SMF, ME, H, HD
313080	58088 SMF		VSG80	80	140	L4	760	315x175x190	B13	0	21,1	42/60	SMF, ME, H, HD
313090	59088 SMF		VSG90	90	161	L5	850	353x175x190	B13	0	23,7	36/60	SMF, ME, H, HD
313005	60518 SMF		VSG10J	105	192	59518	900	306x173x200/221	B01	0	22,8	42/70	SMF, ME, H
313105	60519 SMF		VSG10JX	105	192	59519	900	306x173x200/221	B01	1	22,8	42/70	SMF, ME, H
453612	74027 SMF		VSG24	240	506	C	1250	517x275x214/241	B0	3	59,6	18/24	SMF, ME, H, HD, EMS

# 0 LOW CO<sub>2</sub> EMISSIONS

**VESNA AGM Stop & Go** batteries are Valve Regulated Lead Acid batteries intended for use in vehicles with enhanced level Start-Stop function with break energy recuperation. VRLA AGM battery is improved lead acid battery to its maximum performance. The battery cells are closed by a pressure relief valve and electrolyte is immobilized in absorbed glass mat (AGM). Plate stacks are kept in the cells under pressure.

THE ADVANCED CONSTRUCTION OF BATTERY LEADS TO IMPROVED PERFORMANCE IN:

- + Very low water consumption due to internal oxygen recombination,
- + Preventing active material shedding boast more than three times as much cyclic capability as standard batteries and can be more discharged without any loss of functionality
- + Increased cranking power due to better utilization of cell volume by more than 30 %
- + High rate charge acceptance for recovering energy more quickly during driving phase
- + Both side pasting of plates provides better corrosion resistance providing a longer life time
- + No acid stratification like in flooded cells
- + Explosive safe - minimum explosive gasses are produced
- + Vibration resistance and no acid leakage in case of crash



## VESNA AGM Stop & Go

AGM starter batteries, Ca/Ca technology | CAR batteries

ID	DIN marking	Short code	C20 (Ah)	RC (min)	Box type	EN (A)	L×W×H (mm)	BHD	Layout	Weight (kg)	PCS/Pallet (EUR/CNT)	Remarks
314060	L2 AGM	VAG60	60	109	L2	680	242×175×190	B13	0	17,9	63/90	AGM, H
314070	L3 AGM	VAG70	70	130	L3	760	278×175×190	B13	0	20,5	48/80	AGM, H
314085	L4 AGM	VAG80	80	151	L4	800	315×175×190	B13	0	23,2	42/60	AGM, H
314090	L5 AGM	VAG95	95	184	L5	850	353×175×190	B13	0	26,0	36/60	AGM, H
314105	L6 AGM	VAG105	105	206	L6	950	394×175×190	B13	0	29,2	36/60	AGM, H

